

DPT Modbus

Differential Pressure Transmitter with RS485 Modbus Interface

thermokon
Sensortechnik GmbH

Data sheet

Subject to technical alteration
Issue date: 26.06.2014



Application

Adjustable differential pressure transmitter with RS485 Modbus interface for monitoring the differential pressure of air and other nonflammable and non-aggressive gases.

Possible applications: Monitoring of air filters, fans, industrial cooling air cycles as well as overheating protection, control of air and fire dampers, anti-freeze with heat exchangers. The Input terminal has two input channels designed to accept 0..10 V, NTC10k, PT1000, NI1000/(-LG), and BIN IN (potential free contact) signals.

Types available

Type	Measuring range
DPT-Modbus-2500-D	0...2500Pa
DPT-Modbus-7000-D	0...7000Pa

Security Advice – Caution



The installation and assembly of electrical equipment must be performed by a skilled electrician.

The modules must not be used in any relation with equipment that supports, directly or indirectly, human health or life or with applications that can result in danger for people, animals or real value.

Before connecting the devices the installation must be isolated from power source!

Notes on Disposal

For disposal, the product is considered waste from electrical and electronic equipment (electronic waste) and must not be disposed of as household waste. Special treatment for specific components may be legally binding or ecologically sensible. The local and currently applicable legislation must be observed.

Electrical Connection

The devices are constructed for the operation of protective low voltage (SELV). For the electrical connection, the technical data of the corresponding device are valid.

Especially with regard to passive sensors in 2-wire conductor versions, the wire resistance of the supply wire has to be considered. If necessary the wire resistance has to be compensated by the follow-up electronics. Due to self-heating, the wire current affects the measurement accuracy. So it should not exceed 1 mA.

Sensing devices with transducer should always be operated in the middle of the measuring range to avoid deviations at the measuring end points. The ambient temperature of the transducer electronics should be kept constant. The transducers must be operated at a constant supply voltage ($\pm 0,2$ V). When switching the supply voltage on/off, onsite power surges must be avoided.

When using lengthy connection wires (depending on the cross section used) the measuring result might be falsified due to a voltage drop at the common GND-wire (caused by the voltage current and the line resistance). In this case, 2 GND-wires must be wired to the sensor - one for supply voltage and one for the measuring current.

Technical Data

General	
Power Supply:	24 V = ($\pm 10\%$) / 24 V ~ ($\pm 10\%$)
Power Consumption:	max. 1,3 W
Interface	RS485 Modbus RTU
Accuracy:	(from applied pressure): $\pm 1.5\% + 1$ Pa (Including: general accuracy, temperature drift, linearity, hysteresis, long term stability and repetition error)
Response Time:	1..20 s, selectable via menu
Media:	Air and non-aggressive gases
Measuring Unit:	Selectable via menu (Pa, mbar, inchWC, mmWC, psi)
Measuring Element:	Piezo resistive
Max. Pressure:	400 kPa
Material:	Housing ABS Cover PC Pressure connections Brass Duct connectors ABS Tubing PVC
Pressure Connection:	Male $\varnothing=5,0$ mm / $\varnothing=6.3$ mm

Electrical Connection:	Spring load terminals 4+3, max 1,5 mm ² Cable entry M20
Dimensions (LxWxH):	102,0 x 71,5 x 36,0 mm
Ambient Temperature:	-10..+50 °C, max. 95% rH, no condensate
Storage Temperature:	-20..+70 °C
Protection:	IP54 according to EN 60529
Weight:	150 g, with accessories 290 g
DPT-Modbus-2500-D	
Measuring Range:	0..2500 Pa
Long Term Stability:	± 8 Pa/year
DPT-Modbus-7000-D	
Measuring Range:	0..7000 Pa
Long Term Stability:	± 8 Pa/year

Mounting Advices

- For connecting the device, the process lines must be unpressurized.
- Note the suitability of the device for the medium to be measured.
- Note the maximum pressures.

A prerequisite for the operation is a proper installation of all electrical supply control and sensing leads as well as the pressurized connection line.

Before installing the device, the leak tightness of the pressurized connection lines has to be inspected.

Zero-Point Adjustment

Note! Supply voltage must be connected one hour before the 0-point adjustment is carried out. Access via Modbus or by push button.

1. Loose both tubes from the pressure inlets + and -.
2. Press the select button briefly 
3. Wait until LED turns off and then install tubes again to the pressure inlets.
4. It is recommended to adjust the zero point every 12 months during normal operation.

Installation

Menu

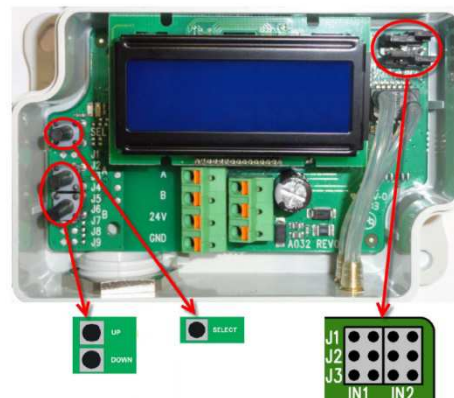
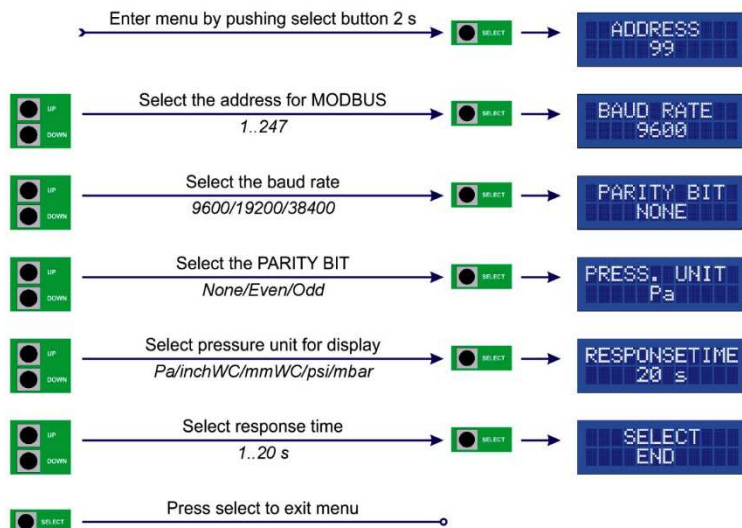

Electrical Connection

- A Modbus Signal A
- B Modbus Signal B
- 24 V Supply 24 V = / 24 V ~
- GND Ground for Supply

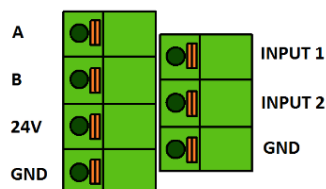

- INPUT 1 Input 1 for external signal
- INPUT 2 Input 2 for external signal
- GND Ground for external signal

Note! If wires are already powered, connect 24 V and GND (Ground for Supply) before connecting outputs!



Input

Input signals can be read over Modbus via DPT MOD RS485 interface.

Signals	Accuracy for measurement	Resolution
0..10 V	<0,5%	0,1%
NTC10k	<0,5%	0,1%
Pt1000	<0,5%	0,1%
NI1000/(-LG)	<0,5%	0,1%
BIN IN (potential free contact)		

Configuration

The jumpers should be set according to the instructions below and the value should be read from the right register. Both inputs can be configured independently.

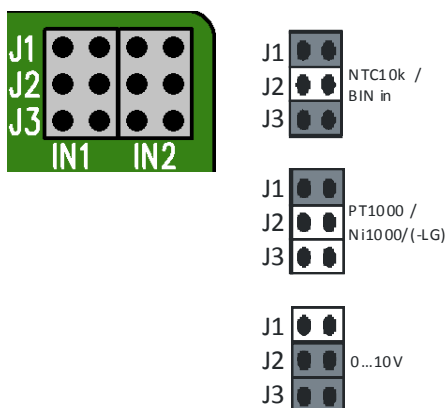

Example:

PT1000 is connected to Input 1
NTC10k is connected to Input 2

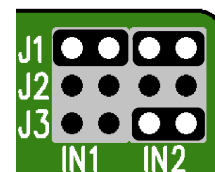
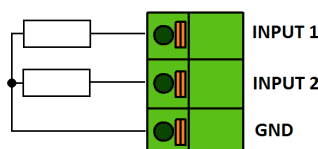

Input 1 - PT1000 temperature:
FUNCTION 04 - Read input Register 3x0005

Input 2 - NTC10k temperature:
FUNCTION 04 - Read input Register 3x0013

Modbus Functions and Registers

The device supports the following functions and registers

FUNCTION 04 – Read input Register

Register	Parameter description	Data type	Value	Range
3x0001	Program version	16 bit	0...1000	0,00...99,00
3x0002	Pressure reading	16 bit	-250...2500	-250...2500 (Pa)
3x0004	Input 1 0...10 V	16 bit	0...1000	0...100 %
3x0005	Input 1 PT1000	16 bit	500...500	-50...+50C
3x0006	Input 1 NI1000	16 bit	-500...500	-50...+50C
3x0007	Input 1 NI1000-LG	16 bit	-500...500	-50...+50C
3x0008	Input 1 NTC10k	16 bit	-500...500	-50...+50C
3x0009	Input 2 0...10 V	16 bit	0...1000	0...100 %
3x0010	Input 2 PT1000	16 bit	-500...500	-50...+50C
3x0011	Input 2 NI1000	16 bit	-500...500	-50...+50C
3x0012	Input 2 NI1000-LG	16 bit	-500...500	-50...+50C
3x0013	Input 2 NTC10k	16 bit	-500...500	-50...+50C

FUNCTION CODE 02 – Read Input status

Register	Parameter description	Data type	Value	Range
1x0001	Input 1 BIN IN	Bit 0	0...1	On - Off
1x0002	Input 2 BIN IN	Bit 0	0...1	On - Off

FUNCTION 05 - Write Single Coil

Register	Parameter Description	Data type	Value	Range
0x0001	Zeroing function	Bit 0	0...1	On - Off

FUNCTION CODE 06 - WRITE SINGLE REGISTER

Register	Parameter description	Data type	Value	Range
4x0001	Beta value of NTC thermistor	16 bit	1...30000	1...30000 (Default: 4220)

Dimensions (mm)

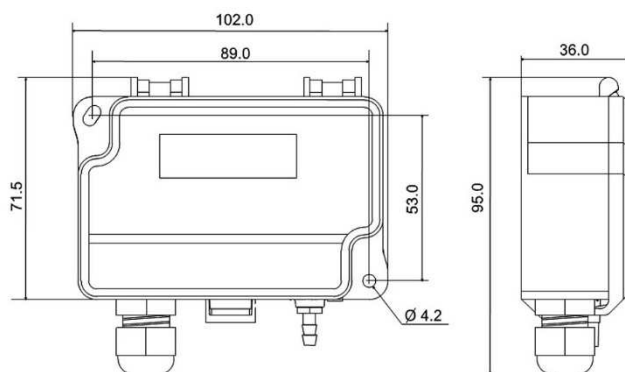

Accessories

- 2 fixing screws
- 2 plastic duct connectors
- 2 m tube \varnothing 4 / 7 mm