

Datasheet

Subject to technical alteration
Issue date: 01.12.2016



Application

EasySens[®] radio surface mounted room sensor for measuring of radiation temperature in room and office applications.

Types Available

Radio room sensor radiation temperature

SR04 IR

Security Advice – Caution



The installation and assembly of the device should only be performed by authorized personnel.

The product should only be used for the intended application. Unauthorised modifications are prohibited! The product must not be used in relation with any equipment that in case of a failure may threaten, directly or indirectly, human health or life or result in danger to human beings, animals or assets. Ensure all power is disconnected before installing. Do not connect to live/operating equipment.

Please comply with

- Local laws, health & safety regulations, technical standards and regulations
- Condition of the device at the time of installation, to ensure safe installation
- This data sheet and installation manual

Notes on Disposal



As a component of a large-scale fixed installation, Thermokon products are intended to be used permanently as part of a building or a structure at a pre-defined and dedicated location, hence the Waste Electrical and Electronic Act (WEEE) is not applicable. However, most of the products may contain valuable materials that should be recycled and not disposed of as domestic waste. Please note the relevant regulations for local disposal.

Guidelines for Devices with Solar Energy Storage

Due to the energy-optimized EnOcean radio technology used in "EasySens[®]" wireless sensors, the devices can work without batteries and self-charge themselves using electric energy generated by integrated solar cells. This makes the devices almost maintenance free and environmentally sound due to not having to replace batteries.

For optimum use, the device should be mounted in a location with sufficient ambient brightness. Minimum illumination of 200 lx (artificial light or ambient) is required for at least 3 to 4 hours each day. (The health and safety regulations at work require a minimum illumination of 500 lx for office workplaces).

The solar cell should be mounted facing towards the window direction if possible. If the device has a temperature sensor, then even periodic direct sun radiation should be avoided due to incorrect false temperature readings.

The mounting position should be selected so that the device will not be obstructed in the future: for example by placement areas, additional furniture or roll-fronted cupboards.

The sensor is supplied in an operational state. If the sensor has been stored in darkness for longer periods, the internal solar energy storage will most likely need to be recharged. This would normally happen automatically during commissioning or during initial start up in ambient light. If the initial charge is not sufficient, the sensor will reach its full operating state up to 3 to 4 days, if the requirements for minimum illumination per day are met. The sensor will then transmit continuously in darkness as specified (2/3 days on factory default telegram timing). Depending on the application it is also possible for the devices to operate in darker rooms (with brightness <100 lx) by using the battery back-up option. Batteries to be used are listed in accessories.

The operating time when using batteries will depend on the transmission frequency as well as the component aging and the self-discharge of the battery. Standard operating time will be 5-10 years on factory default telegram timing. Changing of the device from solar to battery operation is done automatically by simply adding a battery to the device.

Remarks to Room Sensors

Location and Accuracy of Room Sensors

The room sensor should be mounted in a suitable location for measuring accurate room temperature. The accuracy of the temperature measurement also depends directly on the temperature dynamics of the wall. It is important, that the back plate is completely flush to the wall so that there is sufficient circulation of air through the vents in the cover, otherwise, deviations in temperature measurement will occur due to uncontrolled air circulation. The temperature sensor should not be covered by furniture or other objects. Mounting next to doors (due to draught) or windows (due to colder outside wall) should be avoided.

Surface and Flush Mounting

The measuring result is influenced by the thermal characteristics of the wall. A solid concrete wall responds to thermal fluctuations within a room in a much slower than a light-weight structure wall. Room temperature sensors installed in flush-mounted boxes have a longer response time to thermal variations. In extreme cases they detect the radiant heat of the wall even if the air temperature in the room is lower for example. The quicker the dynamics of the wall (temperature acceptance of the wall) or the longer the selected inquiry interval of the temperature sensor is the smaller the deviations limited in time are.

Information about EasySens[®] (radio)

Basic information about EasySens[®] radio, please download from the following link

http://www.thermokon.de/ftp/info/Information_Radio_airConfig_en.pdf



Technical Data

Measuring values	temperature
Radio technology	EnOcean (IEC 14543-3-10)
Frequency	868 MHz
Power supply	solar cell, internal super cap, maintenance free optional: backup battery LS14250
Measuring range temp	0..+40 °C
Accuracy temp	±0,4 K (typ. at 21 °C)
Measuring interval	WakeUp time = 100 sec. (default)
Transmission interval	every 100 sec. at change >0,8 K, otherwise every 1000 sec.
Enclosure	ASA, pure white
Protection	IP30 according to EN 60529
Ambient condition	0..+40 °C, max. 85% rH non-condensing
Weight	50 g
Mounting	to be mounted flat onto the surface using adhesive foil or screws
Delivery content	adhesive foil
Notes	integrated battery backup possibility for usage in dark rooms

Overview of the radio telegrams

EEP

The structure of the data contained in the telegram can be found in the EEP (EnOcean equipment profile) list provided by the EnOcean Alliance: <http://www.enocean-alliance.org/eep/>.



SR04

A5-02-05

Mounting Advice

Installation is made by gluing the sensor base plate to the smooth wall surface by means of the adhesive tape included. If required, the base plate can also be fixed by means of raw plugs and screws. Finally, the sensor is put on the sensor base plate.

The sensor is supplied in an operational status. Probably, the internal solar energy storage must be recharged after a longer storage of the radio sensors in darkness. In principle, the recharging process is done automatically during the first operating hours in daylight. For this purpose, please refer to the remarks "solar energy storage".

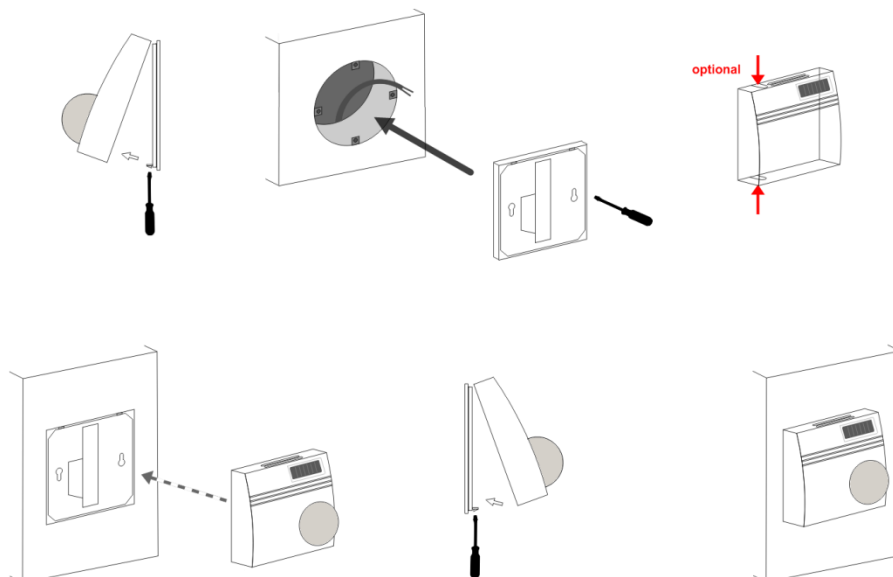







Function Description

The value of the measuring resistors changes in relation with the sensor environment. In fact, the sensor is equipped with two measuring resistors: one for measuring the radiant temperature and the other for the room temperature. The resistor output value is the average of the two measuring one.

Commissioning and Configuration

In order to assure a correct evaluation of the measuring values by the receiver, it is necessary to have the devices learned by the receiver. This is done automatically by means of a "learn button" at the sensor or manually by input of the 32bit sensor ID and a special "learning procedure" between sender and receiver. The respective details are described in the corresponding software documentation of the receiver.

TW (Twake up) TI (Tintervall)

=1		=1	
=10		=10	
=100		=100	

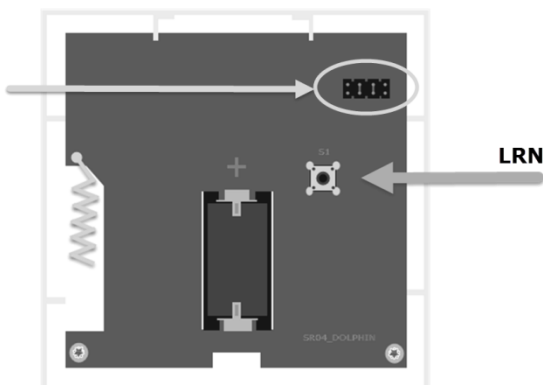

TW (Twake up): Measuring interval | **TI (Tintervall):** Transmission interval

T send = 100 seconds wake up x 10 interval = 1000 seconds = approx. 16 minutes.

Dimensions (mm)

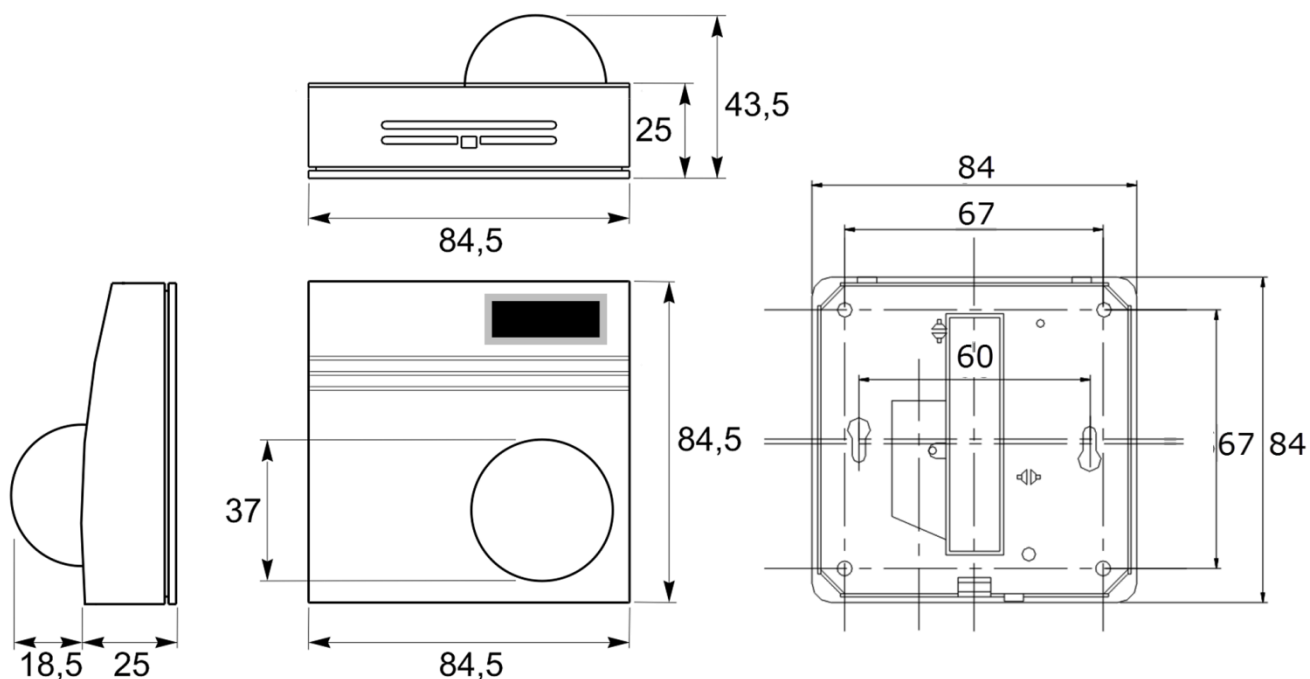

Accessories (optional)

Raw plugs and screws (2 pcs. each)
 Battery LS14250
 Adhesive foil for fixing the base plate

Item No. 102209
 Item No. 315098
 Item No. 234726