



Electrohydraulic actuators for valves

with a 40 mm stroke

SKC32..
SKC82..
SKC62..
SKC60

- **SKC32..** Operating voltage AC 230 V, 3-position control signal
- **SKC82..** Operating voltage AC 24 V, 3-position control signal
- **SKC6..** Operating voltage AC 24 V, control signal DC 0...10 V, 4...20 mA or 0...1000 Ω
- **SKC6..** Choice of flow characteristic, position feedback, stroke calibration, LED status indication, override control
- **SKC62UA** with functions choice of direction of operation, stroke limit control, sequence control with adjustable start point and operating range, operation of frost protection monitors QAF21.. and QAF61..
- **Positioning force 2800 N**
- **Actuator versions with or without spring-return function**
- **For direct mounting on valves; no adjustments required**
- **Manual adjuster and position indicator**
- **Optional functions with auxiliary switches, potentiometer and stem heater**
- **SKC..U are UL-approved**

Use

For the operation of Siemens 2-port and 3-port valves, types VVF.. and VXF.. with a 40 mm stroke as control and safety shut-off valves in heating, ventilation and air conditioning systems.

Types

	Type	Operating voltage	Positioning signal	Spring-return		Positioning time		Enhanced functions
				Function	Time	Opening	Closing	
Standard electronics	SKC32.60	AC 230 V	3-position			120 s	120 s	
	SKC32.61 ²⁾			yes	18 s			
	SKC82.60	AC 24 V						
	SKC82.60U *							
	SKC82.61			yes	18 s			
	SKC82.61U *							
Enhanced electronics	SKC62 ²⁾	DC 0...10 V, 4...20 mA, or 0...1000 Ω	yes	20 s	20 s			
	SKC62U *							
	SKC60							
	SKC62UA *		yes	20 s			yes ¹⁾	

¹⁾ Direction of operation, stroke limit control, sequence control, signal addition

²⁾ Control devices MK..5., MK..6. and MK..5..G are TÜV tested per DIN EN 14597 and can therefore be used as control devices with safety shut-off function for protection against excessive temperature and pressure.

* UL-approved versions

TÜV tested as per DIN EN 14597

Product No.	Stock number	Description	Data sheet
MK..5..	S55329-M1..	Control device PN 25 for safety function per DIN EN 14597, for water	N4387
MK..6.	S55329-M1..	Control device PN 40 for safety function per DIN EN 14597, for water, steam, brine and heat transfer oil	N4388
MK..5..G	S55329-M1..	Control device PN 25 for safety function per DIN EN 14597, for steam	N4389

Accessories

Type	Description	For actuator	Mounting location
ASC1.6	Auxiliary switch	SKC6..	1 x ASC 1.6
ASC9.3	Dual auxiliary switches	SKC32.. SKC82..	1 x ASC9.3 or
ASZ7.3	Potentiometer 1000 Ω		1 x ASZ7.3 or
ASZ7.31	Potentiometer 135 Ω		1 x ASZ7.31 or
ASZ7.32	Potentiometer 200 Ω		1 x ASZ7.32
ASZ6.5	Stem heater AC 24 V	SKC..	1 x ASZ6.5

Ordering

When ordering please specify the quantity, product name and type code.

Example: 1 actuator, type SKC32.60 and

1 potentiometer, 135 Ω, type ASZ7.31

Delivery

The actuator, valve and accessories are supplied in separate packaging and not assembled prior to delivery.

Spare parts

See overview, section «Replacement parts», page 17.

Equipment combinations

Valve type		DN	PN-class	k_{vs} [m ³ /h]	data sheet
Two-port valves VV... (control valves or safety shut-off valves):					
VVF21...	Flange	100	6	124...160	4310
VVF31...	Flange	100...150	10	124...315	4320
VVF40...	Flange	100...150	16	124...315	4330
VVF41...	Flange	65...150	16	49...300	4340
VVF45...	Flange	65...150	16	49...300	4345
VVF43..	Flansch	65...150	16 ¹⁾	50...400	4404
VVF53..	Flansch	65...150	25	63...400	4405
VVF61...	Flange	65...150	40	49...300	4382
Three-port valves VX... (control valves for «mixing» and «diverting»):					
VXF21...	Flange	100	6	124...160	4410
VXF31...	Flange	100...150	10	124...315	4420
VXF40...	Flange	100...150	16	124...315	4430
VXF41...	Flange	65...150	16	49...300	4440
VXF43..	Flansch	65...150	16 ¹⁾	63...400	4404
VXF53..	Flansch	65...150	25	63...400	4405
VXF61...	Flange	65...150	40	49...300	4482

¹⁾ For DN ≤ 50 see VVF53.. or VXF53.. PN 25 (Data sheet N4405): Flange dimensions PN 25 same as for PN 16

For admissible differential pressures Δp_{max} and closing pressures Δp_s , refer to the relevant valve data sheets.

Note Third-party valves with strokes between 12...40 mm can be motorized, provided they are «closed with the de-energized» fail-safe mechanism and provided that the necessary mechanical coupling is available. For SKC32.. and SKC82.. actuators the Y1 signal must be routed via an additional freely-adjustable end switch (ASC9.3) to limit the stroke.
We recommend that you contact your local Siemens office for the necessary information.

Rev. no. Overview table, see page 17.

Technology

Principle of electro-hydraulic actuators

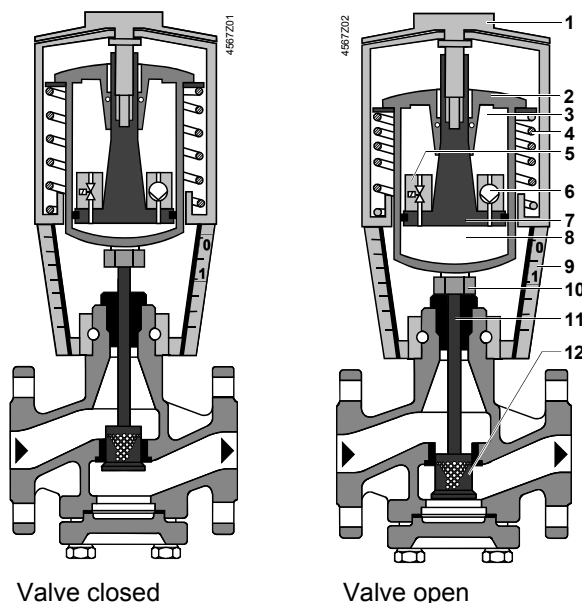

- 1 Manual adjuster
- 2 Pressure cylinder
- 3 Suction chamber
- 4 Return spring
- 5 Solenoid valve
- 6 Hydraulic pump
- 7 Piston
- 8 Pressure chamber
- 9 Position indicator (0 to 1)
- 10 Coupling
- 11 Valve stem
- 12 Plug

Opening the valve	The hydraulic pump (6) forces oil from the suction chamber (3) to the pressure chamber (8) and thereby moving the pressure cylinder (2) downwards. The valve stem (11) retracts and the valve opens. Simultaneously the return spring (4) is compressed.
Closing the valve	Activating the solenoid valve (5) allows the oil in the pressure chamber to flow back into the suction chamber. The compressed return spring moves the pressure cylinder upwards. The valve stem extends and the valve closes
Manual operation mode	Turning the manual adjuster (1) clockwise moves the pressure cylinder downwards and opens the valve. Simultaneously the return spring is compressed. In the manual operation mode the control signals Y and Z can further open the valve but cannot move to the «0%» stroke position of the valve. To retain the manually set position, switch off the power supply or disconnect the control signals Y and Z. The red indicator marked «MAN» is visible.
Note: Controller in manual operation	When setting the controller for a longer time period to manual operation, we recommend adjusting the actuator with the manual adjuster to the desired position. This guarantees that the actuator remains in this position for that time period. Attention: Do not forget to switch back to automatic operation after the controller is set back to automatic control.
Automatic mode	Turn the manual adjuster counterclockwise to the end stop. The pressure cylinder moves upward to the «0%» stroke position of the valve. The red indicator marked «MAN» is no longer visible.
Minimal volumetric flow	The actuator can manually be adjusted to a stroke position > 0 % allowing its use in applications requiring constantly a minimal volumetric flow.
Spring-return facility	The SKC32.61, SKC82.61.. and SKC62.. actuators, which feature a spring-return function, incorporate an additional solenoid valve which opens if the control signal or power fails. The return spring causes the actuator to move to the «0 %» stroke position and closes the valve.
TÜV tested as per DIN EN 14597	Control devices TÜV tested per DIN EN 14597 can be used as control devices with safety shut-off function for protection against excessive temperature and pressure: <ul style="list-style-type: none"> ▪ Water: MK..5.., PN 25, see data sheet N4387 ▪ Steam: MK..5..G, PN 25, see data sheet N4389 ▪ Water, steam, brine, heat transfer oil: MK..6.., PN 40, see data sheet N4388
SKC32../SKC82.. 3-position control signal	The valve is controlled by a 3-position signal either via terminals Y1 or Y2 and generates the desired stroke by means of above described principle of operation. <ul style="list-style-type: none"> • Voltage on Y1 piston extends valve opens • Voltage on Y2 piston retracts valve closes • No voltage on Y1 and Y2 piston / valve stem remain in the respective position
SKC62.., SKC60 Y control signal DC 0...10 V and/or DC 4...20 mA, 0...1000 Ω	The valve is either controlled via terminal Y or override control Z. The positioning signal Y generates the desired stroke by means of above described principle of operation. <ul style="list-style-type: none"> • Signal Y increasing: piston extends valve opens • Signal Y decreasing: piston retracts valve closes • Signal Y constant: piston / valve stem remain in the respective position • Override control Z see description of override control input, page 8
Frost protection monitor Frost protection thermostat	A frost protection thermostat can be connected to the SKC6.. actuator. The added signals from the QAF21.. and QAF61.. require the use of SKC62UA actuators. Notes on special programming of the electronics are described under «Enhanced electronics» on page 5. «Connection diagrams» for operation with frost protection thermostat or frost protection monitor refer to page 15.

Standard electronics
SKC62..., SKC60

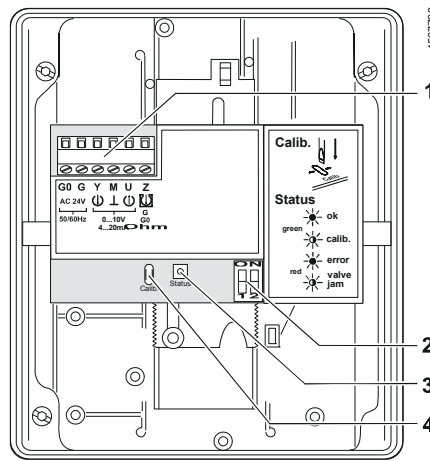

- 1 Connection terminals
- 2 Mode DIL switches
- 3 LED status indication
- 4 Slot for calibration

DIL switches
SKC62..., SKC60

	Positioning signal Y Position feedback U	Flow characteristic
ON	DC 4...20 mA	lin = linear
OFF *)	DC 0...10 V	log = equal percentage

*) Factory setting:
All switches OFF





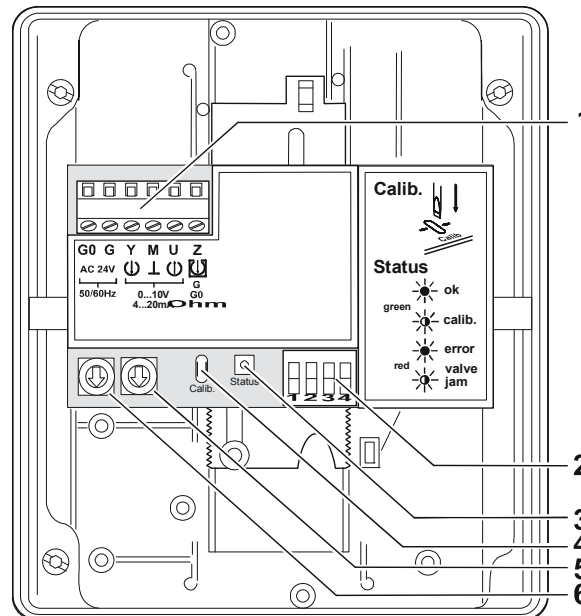



Relationship between control signal Y and volumetric flow

Enhanced electronics
SKC62UA



- 1 Connection terminals
- 2 DIL switches
- 3 LED status indication
- 4 Stroke calibration
- 5 Rotary switch **Up** (factory setting 0)
- 6 Rotary switch **Lo**

DIL switches
SKC62UA

	Direction of operation	Sequence control or stroke limit control	Control signal Y Position feedback U	Flow characteristic
ON	 reverse-acting	 Sequence control Signal addition QAF21../QAF61..	 DC 4...20 mA	 lin = linear
OFF *	 direct-acting	 Stroke limit control	 DC 0...10 V	 log = equal percentage

* Factory settings: all switches OFF

Relationship between control signal Y and volumetric flow

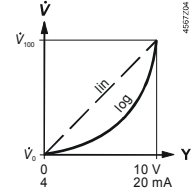

Selection of direction of operation
SKC62UA

- With normally-closed valves, «direct-acting» means that with a signal input of 0 V, the valve closes (applies to all Siemens valves listed under «equipment combinations» on page 3)
- With normally-open valves, «direct-acting» means that with a signal input of 0 V, the valve is open.

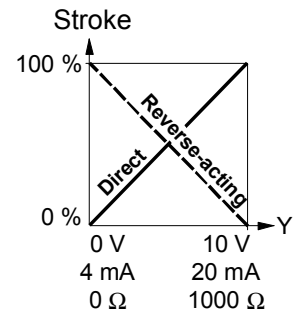
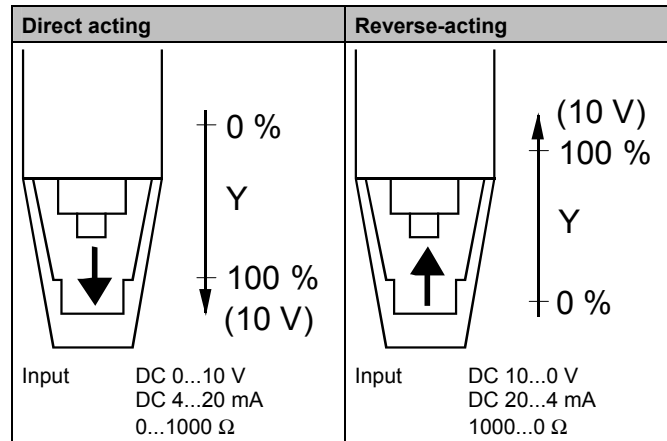

Note The mechanical spring-return function is not affected by the direction of operation selected.

Stroke limit control and sequence control
SKC62UA

Setting the stroke limit control			
The rotary switches LO and UP can be used to apply an upper and lower limit to the stroke in increments of 3%, up to a maximum of 45%			
Position of LO	Lower stroke limit	Position of UP	Upper stroke limit
0	0 %	0	100 %
1	3 %	1	97 %
2	6 %	2	94 %
3	9 %	3	91 %
4	12 %	4	88 %
5	15 %	5	85 %
6	18 %	6	82 %
7	21 %	7	79 %
8	24 %	8	76 %
9	27 %	9	73 %
A	30 %	A	70 %
B	33 %	B	67 %
C	36 %	C	64 %

Setting the sequence control			
The rotary switches LO and UP can be used to determine the starting point or the operating range of a sequence.			
Position of LO	Starting point for sequence control	Position of UP	Operating range of sequence control
0	0 V	0	10 V
1	1 V	1	10 V *
2	2 V	2	10 V **
3	3 V	3	3 V ***
4	4 V	4	4 V
5	5 V	5	5 V
6	6 V	6	6 V
7	7 V	7	7 V
8	8 V	8	8 V
9	9 V	9	9 V
A	10 V	A	10 V
B	11 V	B	11 V
C	12 V	C	12 V

D	39 %	D	61 %
E	42 %	E	58 %
F	45 %	F	55 %

D	13 V	D	13 V
E	14 V	E	14 V
F	15 V	F	15 V

- * Operating range of QAF21.. (see below)
- ** Operating range of QAF61.. (see below)
- *** The smallest adjustment is 3 V; control with 0...30 V is only possible via Y.

Stroke control with
QAF21.. / QAF61..
signal addition
SKC62UA only

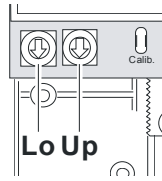

Setting the signal addition			
The operating range of the frost protection monitor (QAF21.. or QAF61..) can be defined with rotary switches LO and UP.			
Position of LO	Sequence control start point	Position of UP	QAF21.. / QAF61.. operating range
0		1	QAF21..
0		2	QAF61..

Calibration
SKC62.., SKC60

In order to determine the stroke positions 0 % and 100 % in the valve, calibration is required on initial commissioning:

Prerequisites

- Mechanical coupling of the actuator SKC6.. with a Siemens valve
- **⚠ Actuator must be in «Automatic operation» enabling stroke calibration to capture the effective 0 % and 100 % values**
- AC 24 V power supply
- Housing cover removed

Calibration

1. Short-circuit contacts in calibration slot (e.g. with a screwdriver)
2. Actuator moves to «0 %» stroke position (1) (valve closed)
3. Actuator moves to «100 %» stroke position (2) (valve open)
4. Measured values are stored

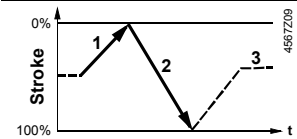
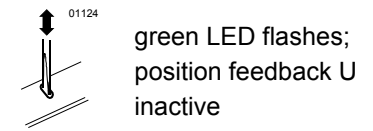

Normal operation

- | | |
|--|---|
| 5. Actuator moves to the position (3) as indicated by signals Y or Z | green LED is lit permanently; position feedback U active, the values correspond to the actual positions |
|--|---|

A lit red LED indicates a calibration error.

The calibration can be repeated any number of times.

The LED status indication indicates operational status with dual-colored LED and is visible with removed cover.

Indication of operating state
SKC62.., SKC60

LED	Indication	Function	Remarks, troubleshooting
Green	Lit	Normal operation	Automatic operation; everything o.k.
	Flashing	Calibration in progress	Wait until calibration is finished (LED stops flashing, green or red LED will be lit)
Red	Lit	Faulty stroke calibration	Check mounting Restart stroke calibration (by short-circuiting calibration slot)
	Flashing	Internal error	Replace electronics
Both	Dark	Inner valve jammed	Check valve
		No power supply Electronics faulty	Check mains network, check wiring Replace electronics

As a general rule, the LED can assume only the states shown above (continuously red or green, flashing red or green, or off).

Override control input Z
SKC62..., SKC60

Override control input can be operated in following different modes of operation

		Z-mode				
		no function	fully open	closed	override with 0...1000 Ω	Signal addition SKC62UA only
Connections						4567210
	Transfer					
		linear or equal-percentage			linear or equal-percentage	linear or equal-percentage
		<ul style="list-style-type: none"> Z-contact not connected Valve stroke follows Y-input 	<ul style="list-style-type: none"> Z-contact connected directly to G Y-input has no effect 	<ul style="list-style-type: none"> Z-contact connected directly to G0 Y-input has no effect 	<ul style="list-style-type: none"> Z-contact connected to M via resistor R Starting position at 50 Ω / end position at 900 Ω Y-input has no effect 	<ul style="list-style-type: none"> Z-contact is connected to R of the frost protection monitor QAF21.. or QAF61.. Valve stroke follows signals Y and R(Z)

Note Shown operation modes are based on the factory setting «direct acting»
Y-input has no effect in Z-mode.

Accessories

SKC..

ASZ6.5
stem heater

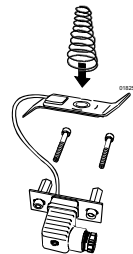

- for media below 0 °C
- mount between valve and actuator

SKC32..., SKC82..

ASC9.3
double auxiliary switch

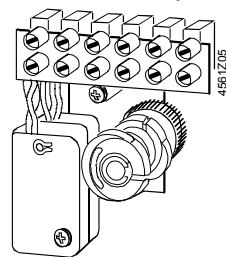

adjustable switching points

ASZ7.3..
potentiometer

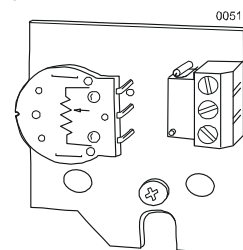

- ASZ7.3: 0...1000 Ω
- ASZ7.31: 0...135 Ω
- ASZ7.32: 0...200 Ω

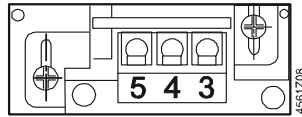

switching point 0...5 % stroke

See section «Technical data» on page 12 for more information.

Engineering notes

Conduct the electrical connections in accordance with local regulations on electrical installations as well as the internal or connection diagrams.

Caution

Safety regulations and restrictions designed to ensure the safety of people and property must be observed at all times!

Caution

For media below 0 °C the ASZ6.5 stem heater is required to keep the valve from freezing. For safety reasons the stem heater is designed for an operating voltage of AC 24 V / 30 W.

For this case, do not insulate the actuator bracket and the valve stem, as air circulation must be ensured. Do not touch the hot parts without prior protective measures to avoid burns.

Non-observance of the above may result in accidents and fires!

Recommendation: Above 140 °C insulating the valves is strictly recommended.

Observe admissible temperatures, refer to «Use» on page 1 and «Technical data» on page 12

If an auxiliary switch is required, its switching point should be indicated on the plant schematic.

Every actuator must be driven by a dedicated controller (refer to «Connection diagrams», page 15).

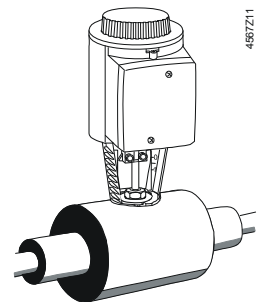

487211

Mounting instructions

Mounting Instruction 74 319 0324 0 for fitting the actuator to the valve are by packed in the actuator packaging. The instructions for accessories are enclosed with the accessories themselves.

Accessories	Installation instructions		Accessory	Mounting instructions	
ASC1.6	G4563.3	4 319 5544 0	ASZ6.5	M4563.7	4 319 5564 0
ASC9.3	G4561.3	4 319 5545 0	ASZ7.3..		74 319 0247 0
SKC..	M3240	74 319 0324 0	ACT control unit	M4568	74 319 0554 0
SKC..		74 319 0326 0	QAF21..		74 319 0399 0

Orientation

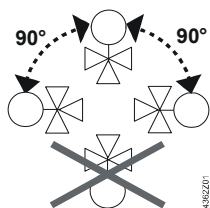

486201

When commissioning the system, check the wiring and functions, and set any auxiliary switches and potentiometers as necessary, or check the existing settings.

Cylinder with valve stem connector fully retracted
→ stroke = 0%

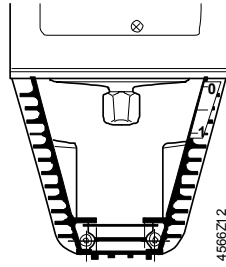

Cylinder with valve stem connector fully extended
→ stroke = 100 %

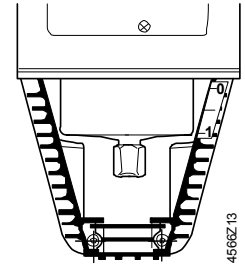

The manual adjuster must be rotated counterclockwise to the end stop. This causes the Siemens valves, types VVF.. and VXF.. to close (stroke = 0 %).

Automatic operation

For automatic operation, the crank (2) on the manual adjustment knob (1) must be engaged. If not engaged, turn the crank counter-clockwise until the display window (3) neither shows the scale (4) nor the crank engagement bar.

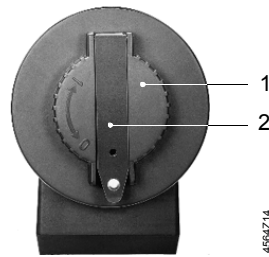

Engaged crank (2) on the manual adjustment knob (1)

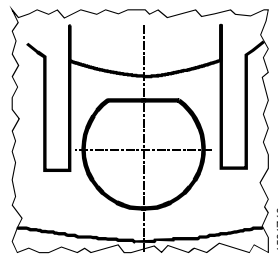

Display window with invisible scale dial and crank engagement bar

Manual operation

For manual operation, swing out the crank (2) so that the display window (3) becomes visible. By rotating the crank or the manual adjustment knob (1), the display window shows the engagement bar and/or the scale dial with stroke indication.

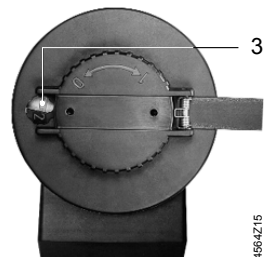

Swung-out crank, display window (3)

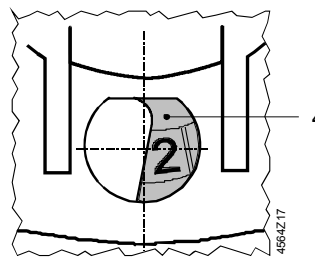

Display window with scale dial (4) and stroke indication

Maintenance notes

The SKC.. actuators are maintenance-free.



When servicing the actuator:

- Switch off pump of the hydronic loop
- Interrupt the power supply to the actuator
- Close the main shutoff valves in the system
- Release pressure in the pipes and allow them to cool down completely
- If necessary, disconnect electrical connections from the terminals
- The actuator must be correctly fitted to the valve before recommissioning.

Recommendation SKC6...: trigger stroke calibration.

Repair

«Replacement parts», see page 17.



A damaged housing or cover represents an injury risk

- **NEVER** uninstall an actuator from the valve
- **Uninstall the valve-actuator combination (actuating device) as a complete device**
- **Use only properly trained technicians to uninstall the unit**
- **Send the actuating device together with an error report to your local Siemens representative for analysis and disposal**
- **Properly mount the new actuating device (valve and actuator)**

Parts could fly ultimately resulting in injuries from uninstalling an actuator with a damaged valve housing due to the tensioned return spring.

Disposal



The device contains electrical and electronic components and must not be disposed of together with domestic waste. This applies in particular to the PCB.

Legislation may demand special handling of certain components, or it may be sensible from an ecological point of view.

Current local legislation must be observed.

Warranty

The technical data relating to specific applications are valid only in conjunction with the valves listed in this Data Sheet under «Equipment combinations», page 3.



The use of the actuators in conjunction with third-party valves invalidates all claims under Siemens Switzerland Ltd warranty.

Technical data

		SKC32..	SKC82..	SKC6..	
Power supply	Operating voltage	AC 230 V	AC 24 V	AC 24 V	
	Voltage tolerance	± 15 %	± 20 %	-20 % / +30 %	
		SELV / PELV			
	Frequency	50 or 60 Hz			
	Max. Power consumption at 50 Hz	SKC32.60: 19 VA / 16 W SKC32.61: 24 VA / 21 W	SKC82.60, ..60U 19 VA / 16 W SKC82.61, ..61U 24 VA / 21 W	SKC62.. 28 VA / 20 W SKC60 24 VA / 18 W	
External supply cable fuse	min. 0.5 A, slow max. 6 A, slow	min. 1.6 A, slow max. 10 A, slow			
Signal inputs	Control signal	3-position		DC 0...10 V, DC 4...20 mA, 0...1000 Ω	
	Terminal Y	Voltage Input impedance Current Input impedance Signal resolution Hysteresis		DC 0...10 V 100 kΩ DC 4...20 mA 240 Ω < 1% 1 %	
	Terminal Z Override control	Resistor Z not connected Z connected directly to G Z connected directly to G0 Z connected to M via 0...1000 Ω		0...1000 Ω No function, priority terminal Y max. stroke 100 % min. stroke 0 % stroke proportional to R	
	Terminal U	voltage load impedance current load impedance		DC 0...9,8 V ±2 % > 10 kΩ DC 4...19,6 mA ±2 % < 500 Ω	
Operating data	Positioning time at 50 Hz	opening	SKC32.6.. 120 s	SKC82.6.. 120 s	120 s
		Closing	SKC32.6.. 120 s	SKC82.6.. 120 s	20 s
	Spring-return time (closing)	SKC32.61 18 s	SKC82.61 18 s	SKC60 -	
		SKC32.60 -	SKC82.60 -	SKC62.. 20 s	
	Positioning force	2800 N			
	Nominal stroke	40 mm			
	Max. permissible medium temperature	-25...220 (350) °C < 0 °C: requires stem heater ASZ6.5			
Electrical connections	Cable entry ..U	4 x M20 (Ø 20,5 mm) with knockouts for standard ½" conduit connectors (Ø 21.5 mm)			
Norms and standards	CE-conformity	2004/108/EC			
	EMC-directive	Immunity EN 61000-6-2 Industrial Emission EN 61000-6-3 Residential			
	Low voltage directive	2006/95/EC			
	Electrical safety	EN 60730-1			
	Product standards for automatic electric controls	EN 60730-2-14			
	Protection standard EN 60730	I	III		
	Housing protection standard Upright to horizontal	IP54 to EN 60529			
	Conform with UL standards	SKC82..U	UL 873		

		SKC32..	SKC82..	SKC6..
		SKC62U, SKC62UA		UL873
C-tick			N474	N474
Environmental compatibility	ISO 14001 (Environment) ISO 9001 (Quality) SN 36350 (Environmentally compatible products) RL 2002/95/EG (RoHS)			
Dimensions / Weight	Dimensions	refer to «Dimensions», page 16		
	Weight	SKC32.60 9.80 kg SKC32.61 10.00 kg	SKC82.60 9.90 kg SKC82.60U 10.15 kg SKC82.61 10.00 kg SKC82.61U 10.25 kg	SKC60/62 9.95 kg SKC62U/UA 10.20 kg
Materials	Actuator housing, bracket	Die-cast aluminum		
	Housing box and manual adjuster	Plastic		

Accessories		SKC32.., SKC82..	SKC6..
ASC1.6 Auxiliary switch	Switching capacity		AC 24 V, 10 mA...4 A resistive, 2 A inductive
ASC9.3 double auxiliary switch	Switching capacity per auxiliary switch	AC 250 V, 6 A resistive, 2.5 A inductive	
ASZ7.3 Potentiometer	Change in overall resistance of potentiometer at nominal stroke	ASZ7.3 0...1000 Ω ASZ7.31 0...135 Ω ASZ7.32 0...200 Ω	
	min. current in sliding contact	0,05 mA	
	expected lifetime	250'000 full lifts	
	max. current in sliding contact	2,5 mA	
	expected lifetime	100'000 full lifts	
ASZ6.5 stem heater	Operating voltage	AC 24 V ± 20 %	
	Power consumption	30 VA	

SKC62UA enhanced functions

Direction of operation	Direct-acting, reverse-acting	DC 0...10 V / DC 10...0 V DC 4...20 mA / DC 20...4 mA 0...1000 Ω / 1000...0 Ω
Stroke limit control	Range of lower limit	0...45 % adjustable
	Range of upper limit	100...55 % adjustable
Sequence control	Terminal Y	
	Starting point of sequence	0...15 V adjustable
	Operating range of sequence	3...15 V adjustable
Signal addition	Z connected to R of	
	Frost protection monitor QAF21..	0...1000 Ω, added to Y signal
	Frost protection monitor QAF61..	DC 1.6 V, added to Y signal

General ambient conditions

	Operation EN 60721-3-3	Transport EN 60721-3-2	Storage EN 60721-3-1
Environmental conditions	Class 3K5	Class 2K3	Class 1K3
Temperature	-15...55 °C	-30...65 °C	-15...55 °C
Humidity	5...95 % r.h.	< 95 % r.h.	5...95 % r.h.

Internal diagrams

SKC32.61
AC 230 V, 3-Position

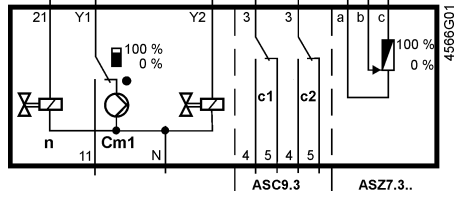

- Cm1** end switch
- n** solenoid valve for spring-return
- c1, c2** ASC9.3 double auxiliary switch
- a, b, c** ASZ7.. potentiometer
- Y1** Positioning signal «open»
- Y2** Positioning signal «close»
- 21** spring-return function
- N** neutral conductor

SKC32.60
AC 230 V, 3-Position

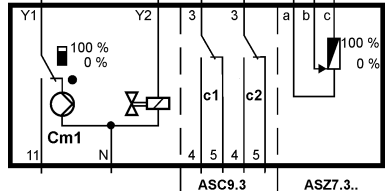

SKC82.61
AC 24 V, 3-Position

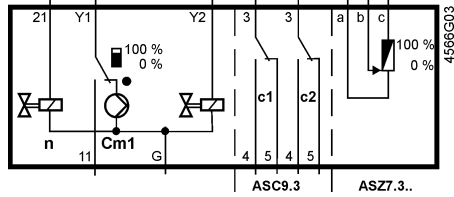

- Cm1** end switch
- n** solenoid valve for spring-return
- c1, c2** ASC9.3 double auxiliary switch
- a, b, c** ASZ7.. potentiometer
- Y1** Positioning signal «open»
- Y2** Positioning signal «close»
- 21** spring-return function
- G** System potential

SKC82.60
AC 24 V, 3-Position

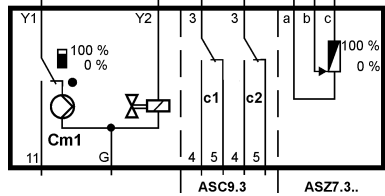

SKC60, SKC62
SKC60U, SKC62U
SKC62UA
AC 24 V, DC 0...10 V,
4...20 mA, 0...1000 Ω

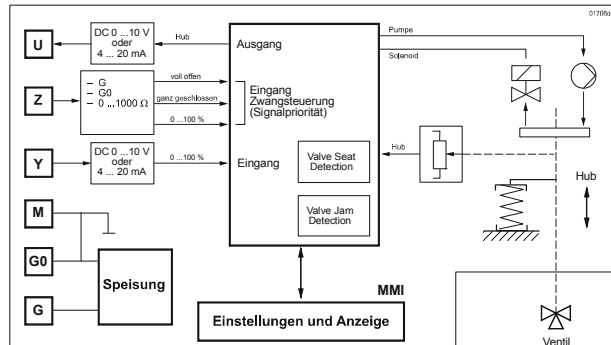

- U** position indication
- Z** override control
- Y** positioning signal
- M** measuring neutral
- G0** operating voltage AC 24 V: system neutral (SN)
- G** operating voltage AC 24 V: system potential (SP)

Connection terminals

SKC6..

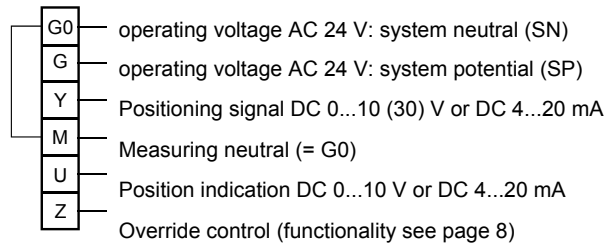

Auxiliary switch
ASC1.6

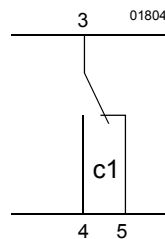

Connection diagrams

SKC32..
AC 230 V
3-Position

SKC32.61
AC 230 V

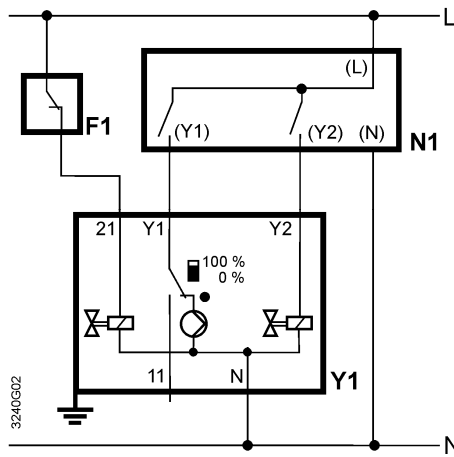

F1 temperature limiter
N1, N2 controller
Y1, Y2 actuators
L Phase
N neutral

SKC32.60
AC 230 V

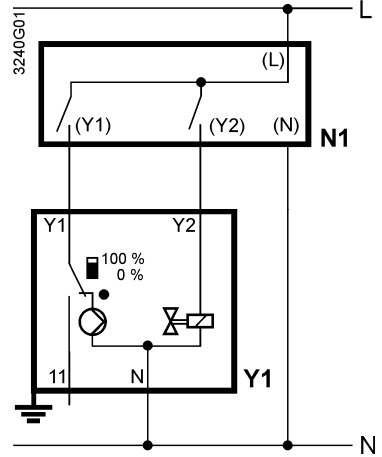

Y1 Positioning signal «open»
Y2 Positioning signal «close»
21 Spring-return function

SKC82..
AC 24 V
3-Position

SKC82.61, SKC82.61U
AC 24 V

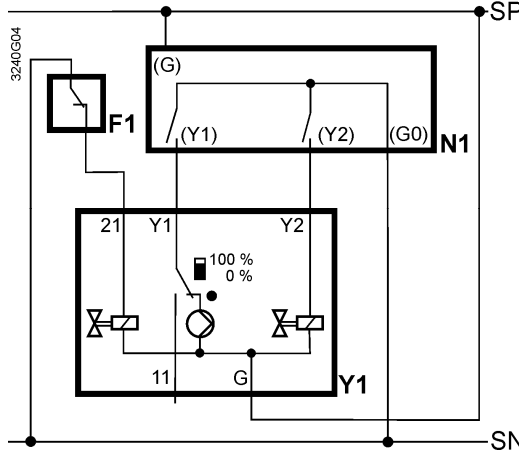

F1 temperature limiter
N1, N2 controller
Y1, Y2 actuators
SP Systempotential AC 24 V
SN System neutral

SKC82.60, SKC82.60U
AC 24 V

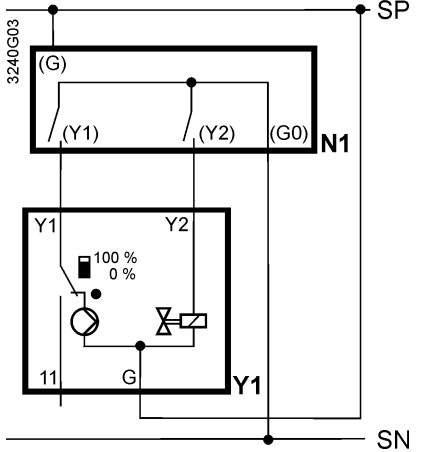

Y1 Positioning signal «open»
Y2 Positioning signal «close»
21 Spring-return function

SKC6..
AC 24 V
DC 0...10 V, 4...20 mA,
0...1000 Ω

SKC60
AC 230 V
AC 24 V

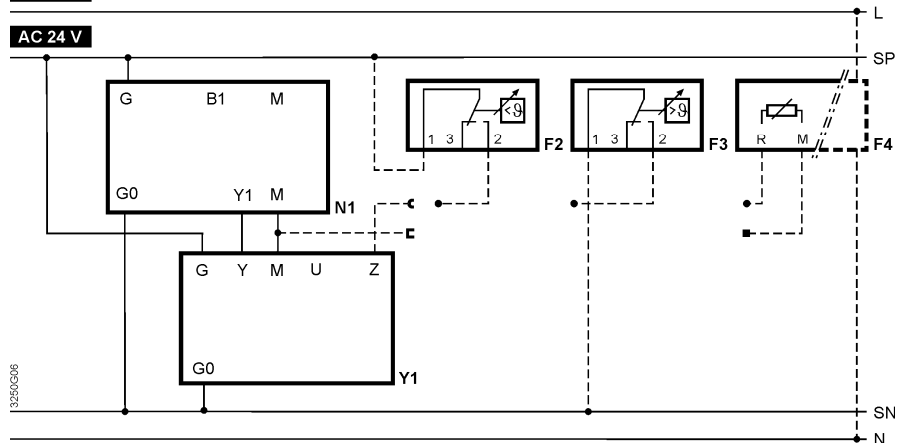

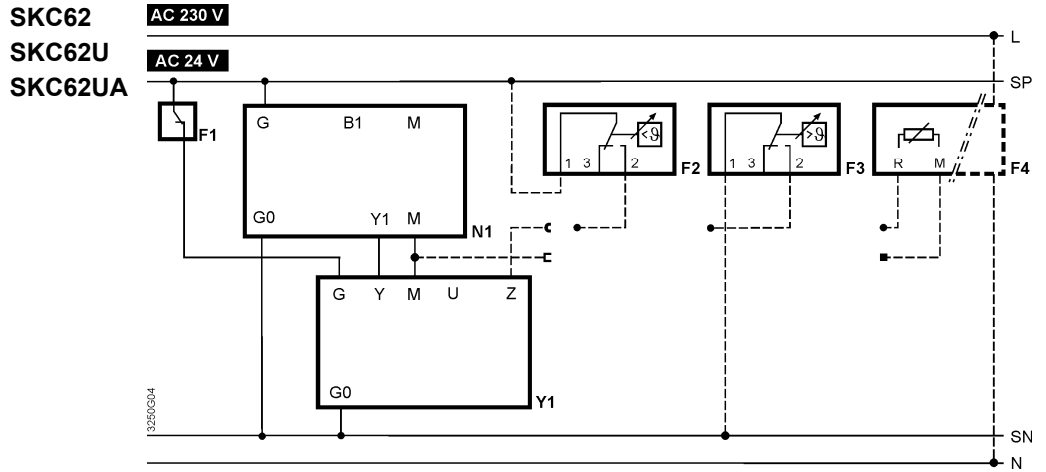

- Y1** actuator
N1 controller
F1 temperature limiter
F2 frost protection thermostat
 terminals: 1 – 2 frost hazard / sensor is interrupted (thermostat closes with frost)
 1 – 3 normal operation
F3 temperature detector
F4 Frost protection monitor with 0...1000 Ω signal output, e.g. QAF21.. or QAF61.. (only SKB62UA) *
G (SP) System potential AC 24 V
G0 (SN) System neutral
 * Only with sequence control and the appropriate selector switch settings (see page 5ff)



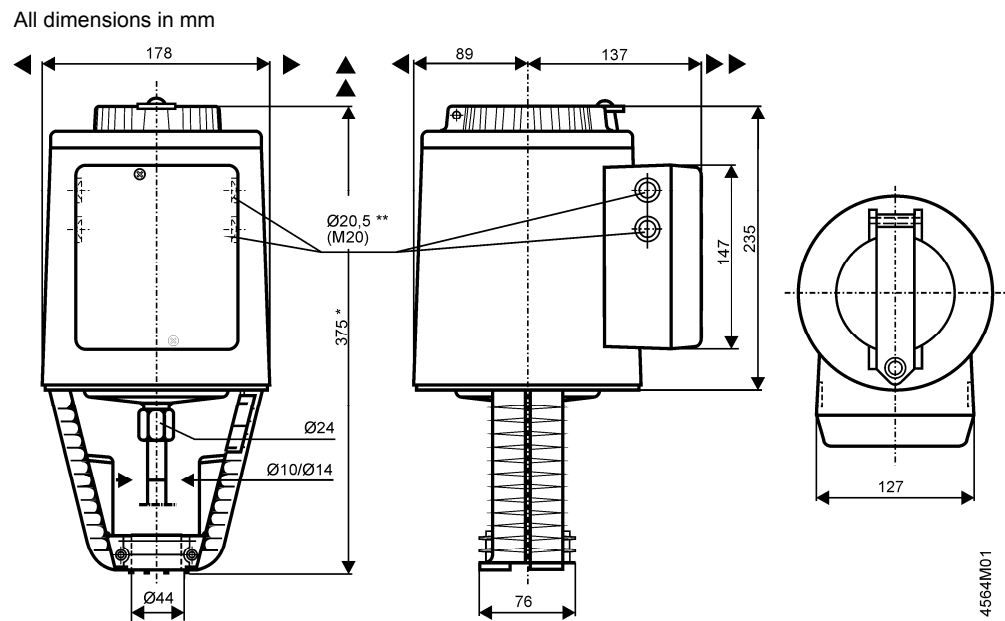

Dimensions

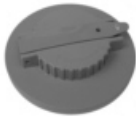

- ** SKC..U:** with knockouts for standard 1/2" conduit connectors (Ø 21.5 mm)
 ► = > 100 mm, minimum clearance from ceiling or wall for mounting,
 ►► = > 200 mm, connection, operation, maintenance etc.

Replacement parts

Order numbers for replacement parts

Actuator type	Cover	Hand control ¹⁾	Clamp	Stem connection	Control unit
					
SKC32.60	410455828	426855108	410355768	417856498	
SKC32.61	410455828	426855108	410355768	417856498	
SKC82.60	410455828	426855108	410355768	417856498	
SKC82.60U	410455828	426855108	410356058	417856498	
SKC82.61	410455828	426855108	410355768	417856498	
SKC82.61U	410455828	426855108	410356058	417856498	
SKC62	410455828	426855108	410355768	417856498	466857488
SKC62U	410455828	426855108	410356058	417856498	466857488
SKC60	410455828	426855108	410355768	417856498	466857598
SKC62UA	410455828	426855108	410356058	417856498	466857518

1) hand control, blue with mechanical parts

Revision numbers

Type reference	Valid from rev. No.	Type reference	Valid from rev. No.
SKC32.60	..C	SKC82.61U	..C
SKC32.61	..C	SKC62	..F
SKC82.60	..C	SKC62U	..F
SKC82.60U	..C	SKC60	..F
SKC82.61	..C	SKC62UA	..F

